

# SPRING PUZZLE PACK



# Design Credits:



**Fonts: Bunny on a Cloud**

**Graphics: Creative Fabrica, Midjourney**





# Find Us on Social Media:

 [troutlakecreations@gmail.com](mailto:troutlakecreations@gmail.com)

 [www.canoesandcreativity.com](http://www.canoesandcreativity.com)

 [@troutlakecreations](https://www.instagram.com/troutlakecreations)

 [@troutlakecreations](https://www.youtube.com/troutlakecreations)



























 [@troutlakecreations](https://www.pinterest.com/troutlakecreations)



## Join Our Newsletter:

Get Access to Free Classroom Resources. Sign Up [HERE](#)

# SECRET MESSAGE

A= 	F= 	K= 	P= 	U= 
B= 	G= 	L= 	Q= 	V= 
C= 	H= 	M= 	R= 	W= 
D= 	I= 	N= 	S= 	X= 
E= 	J= 	O= 	T= 	Y= 
				Z= 

## DECODE THE HINTS:

1



2

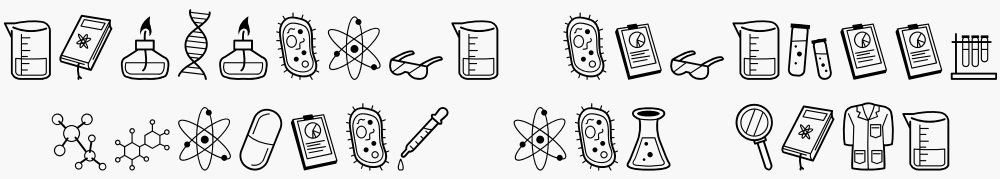

3

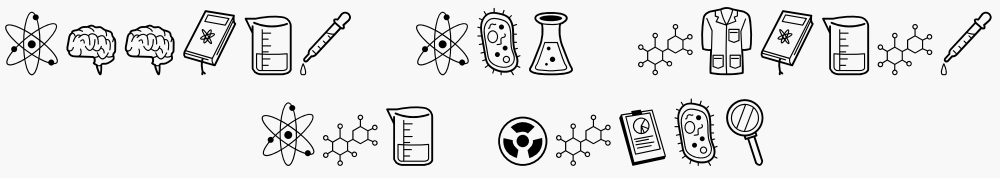

## WHAT'S MISSING?

BOOKS	GLUE	NOTEBOOK	CRAYONS
RULERS	APPLES	TAPE	PENS

# H I N T   S E A R C H

Uh Oh! The words to find in the word search are missing! Your job is to find SIX words related to the topic or theme. Use the hints below to find the words. Then, unscramble the letters in the SHADED boxes.

## THEME:

School Supplies

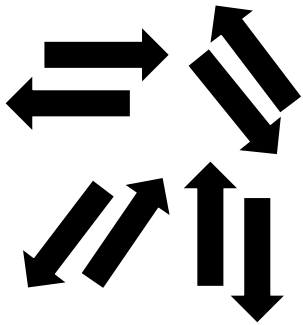

C	D	G	E	F	B	W	R
G	T	U	Y	I	H	E	E
S	L	F	N	G	K	T	P
G	R	D	M	R	C	K	A
P	E	C	A	G	G	P	P
R	B	M	S	H	B	S	B
P	N	O	Y	A	R	C	G
S	C	I	S	S	O	R	S

1. C

2. M

3. B

4. S

5. P

6. G

MYSTERY WORD

# SUDOKU SQUARES

Puzzle #1

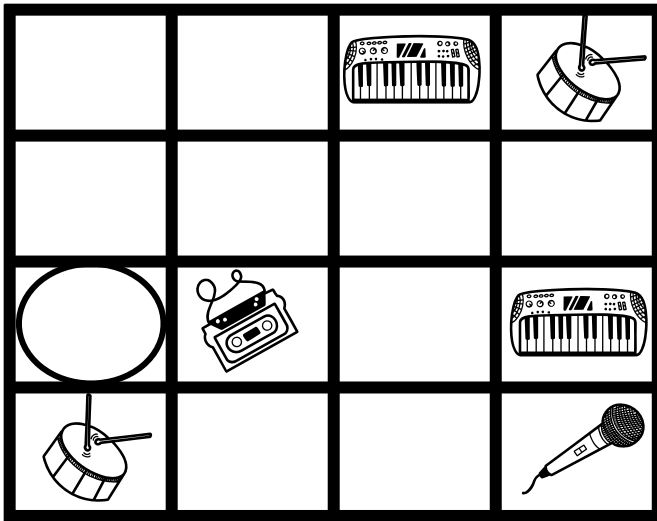

Puzzle #2

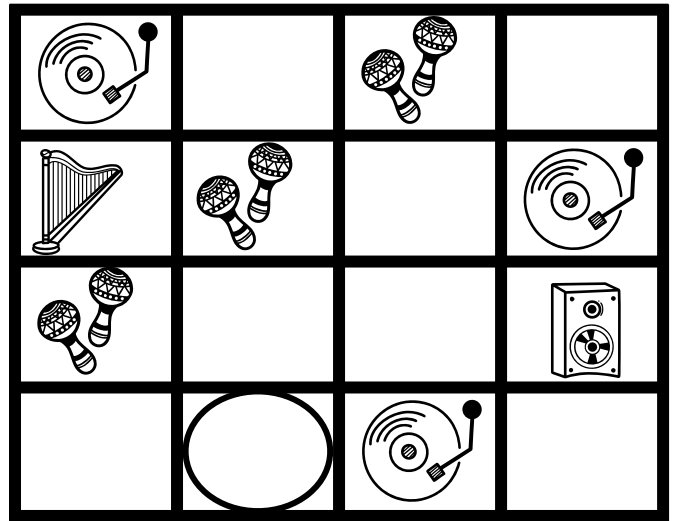

Puzzle #3

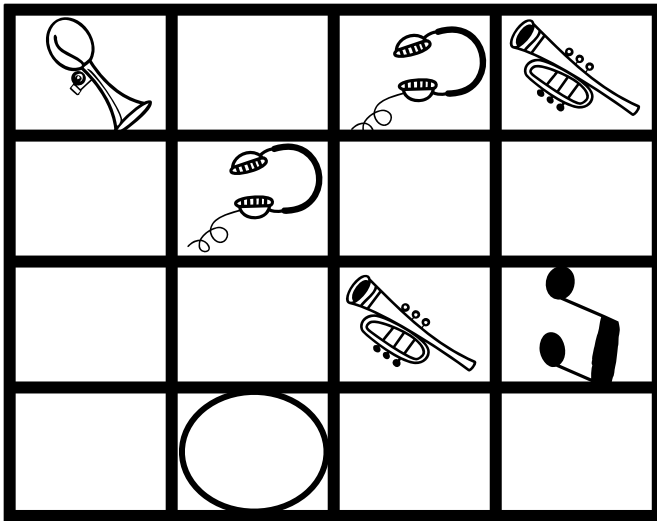

Puzzle #4

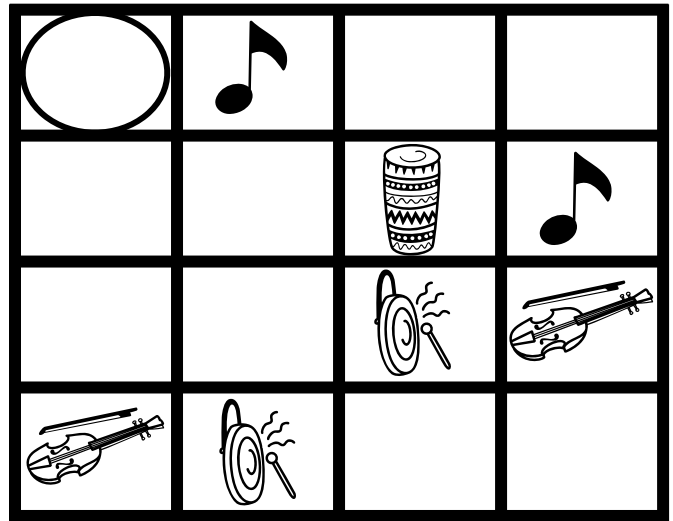

Puzzle #5

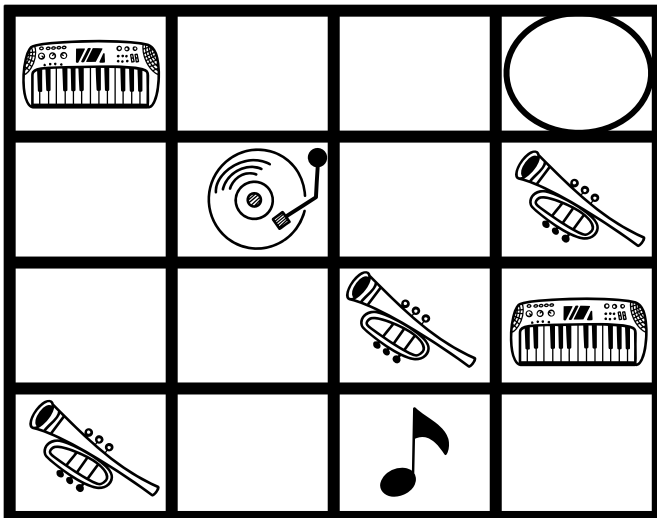



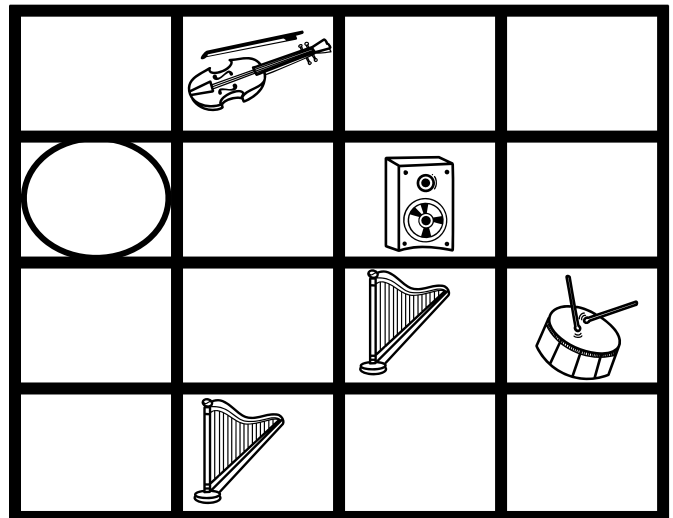

















Puzzle #6























# SNACK PICTURE LOGIC

Use your math skills to find the value of the pictures. Then, total (add) the value of ALL missing numbers to determine your mystery #.

	+		=	10
	+		=	8
	+		=	12
	+		=	11
What is the value of the pack of cookies?				<input type="text"/>

	+		+		=	26
	+		+		=	52
	+		+		=	56
	+		+		=	16
What is the value of the candy?				<input type="text"/>		

	+		=	14
	+		=	26
	+		=	37
	+		=	21
What is the value of the gum?				<input type="text"/>

	+		+		=	75
	+		+		=	31
	+		+		=	39
	+		+		=	20
What is the value of the popcorn?				<input type="text"/>		

MYSTERY NUMBER 

# TOTAL TRIVIA

Read each statement below and determine if it is true or false. If the statement is true, colour the coin that corresponds to that question. If it is false, cross out the coin. When you are finished add the TOTAL of ALL TRUE coins.



A. Niagara Falls is located entirely within Canada.



B. The Canadian Rockies are part of the longest mountain range in the world.



C. Canada is home to the world's longest street, Yonge Street in Toronto.

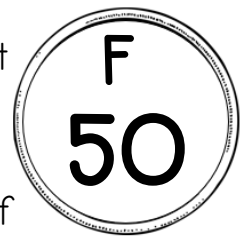

D. Hockey is the official national sport of Canada.

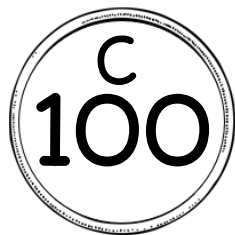

E. Canada has more lakes than any other country in the world.



F. The world's largest beaver dam is located in Wood Buffalo National Park, Canada.



G. Canada is the second-largest country in the world by land area, after Russia.



H. The North Pole is located within Canadian territory.

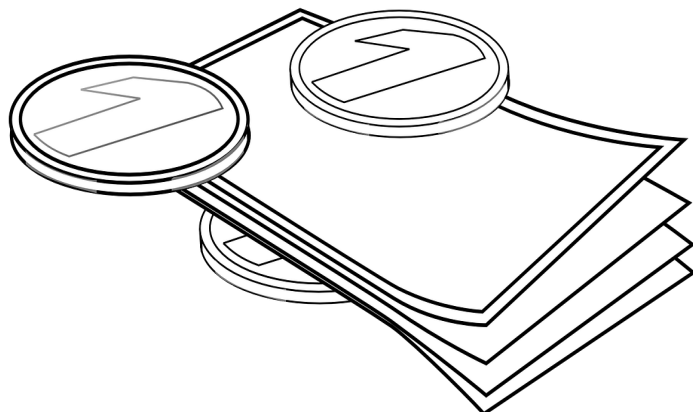

## TOTAL

\$



# SECRET MESSAGE

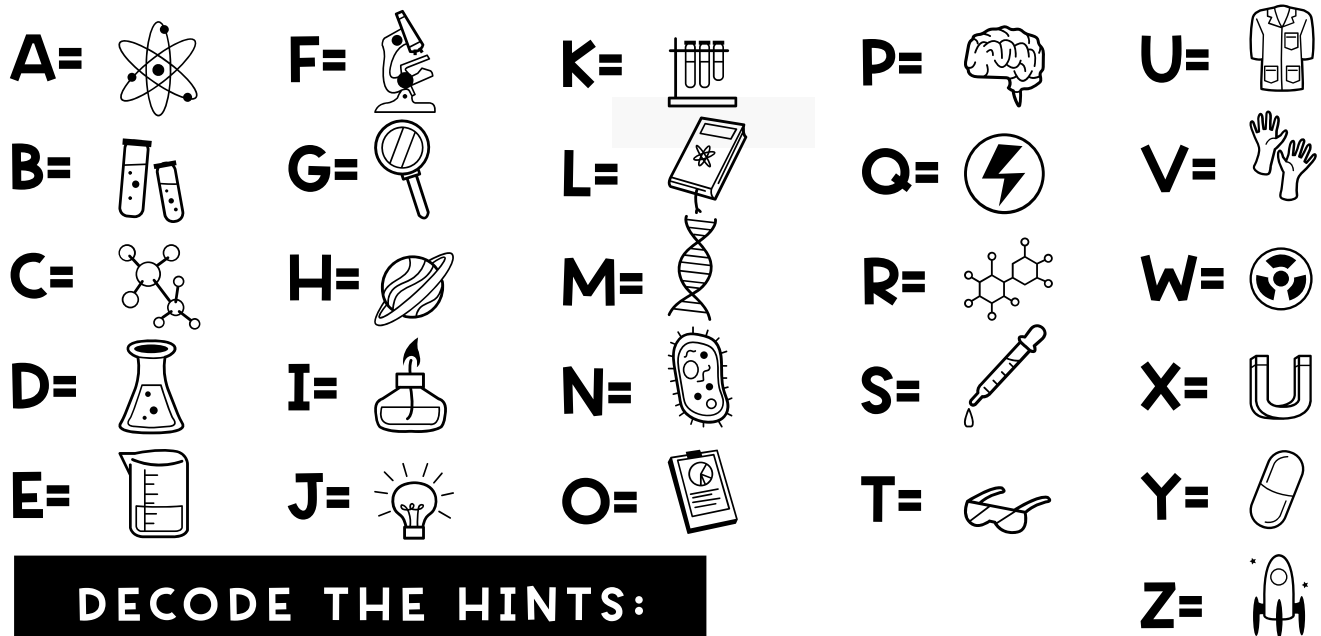

## DECODE THE HINTS:

1

THE ANSWER IS NOT  
BOOKS OR PENS

2

ELIMINATE NOTEBOOK  
CRAYONS AND GLUE

3

APPLES AND RULERS  
ARE WRONG

## WHAT'S MISSING?

BOOKS

GLUE

NOTEBOOK

CRAYONS

RULERS

APPLES

TAPE

PENS

# H I N T   S E A R C H

Uh Oh! The words to find in the word search are missing! Your job is to find SIX words related to the topic or theme. Use the hints below to find the words. Then, unscramble the letters in the SHADED boxes.

## THEME:

School Supplies

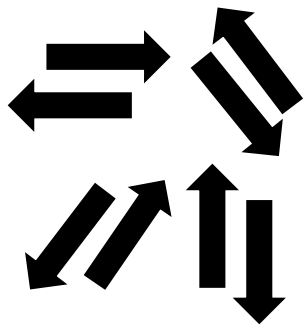

C	D	G	E	F	B	W	R
G	T	U	Y	I	H	E	E
S	L	F	N	G	K	T	P
G	R	D	M	R	C	K	A
P	E	C	A	G	G	P	P
R	B	M	S	H	B	S	B
P	N	O	Y	A	R	C	G
S	C	I	S	S	O	R	S

1. C R A Y O N

4. S C I S S O R S

2. M A R K E R

5. P A P E R

3. B I N D E R

6. G L U E

MYSTERY WORD

PENCIL

# SUDOKU SQUARES

Puzzle #1

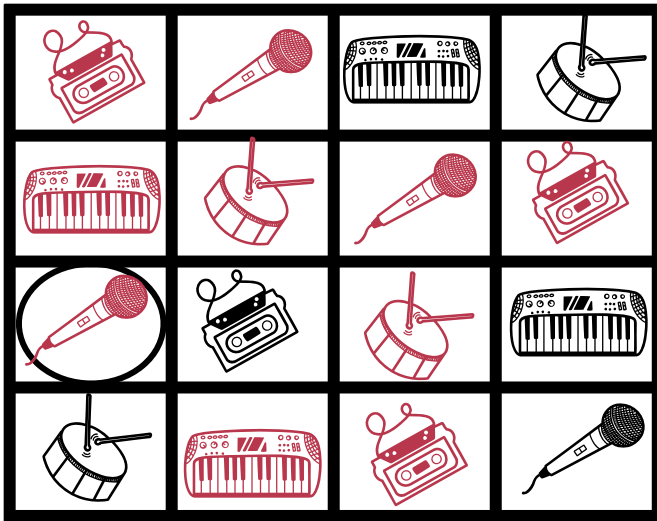

Puzzle #2

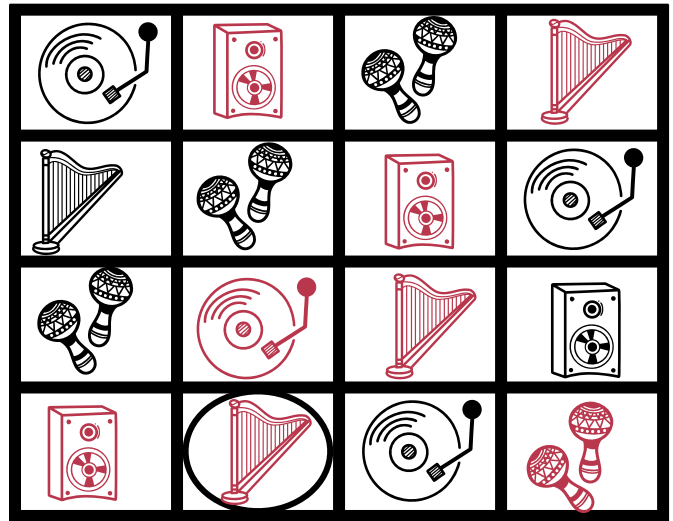

Puzzle #3

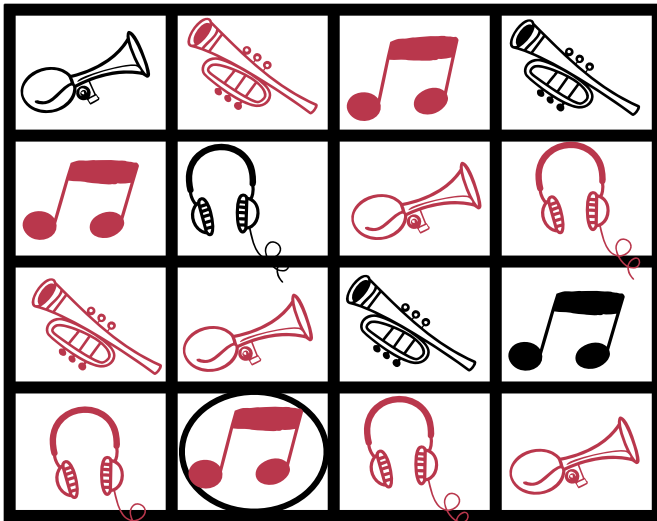

Puzzle #4

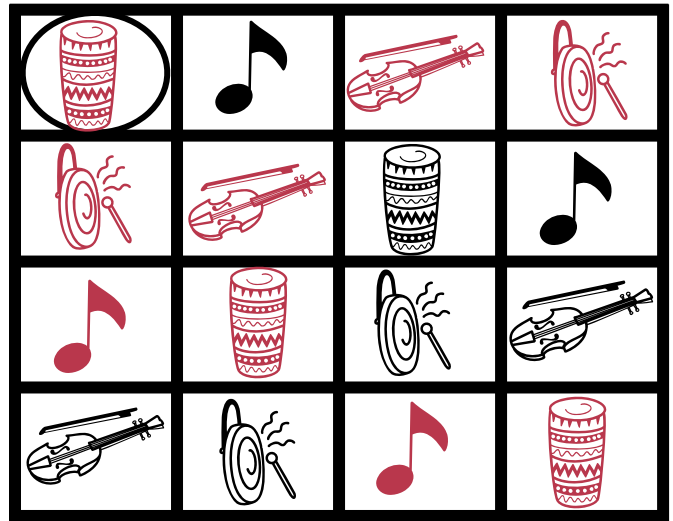

Puzzle #5

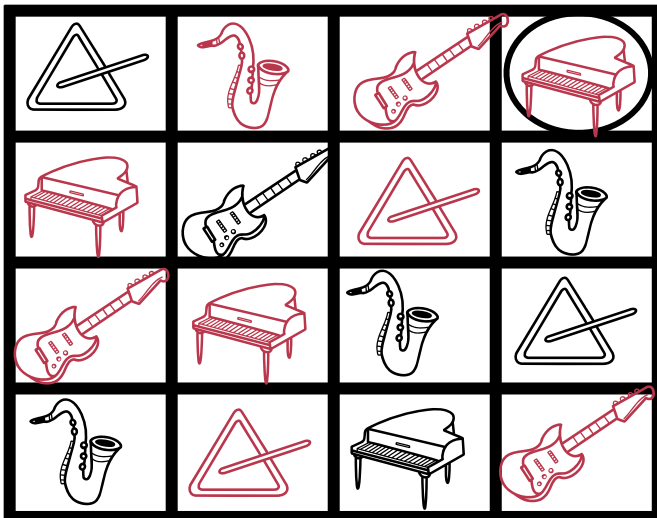

Puzzle #6

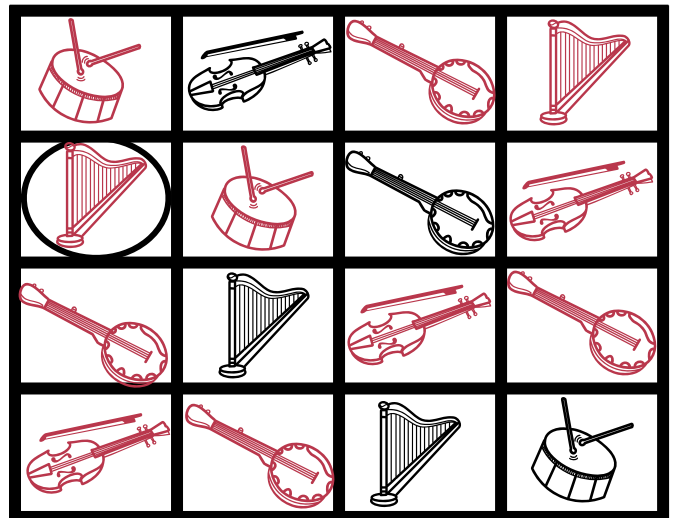

# SNACK PICTURE LOGIC

Use your math skills to find the value of the pictures. Then, total (add) the value of ALL missing numbers to determine your mystery #.

$$5 + 5 = 10$$

$$5 + 3 = 8$$

$$3 + 9 = 12$$

$$9 + 2 = 11$$

What is the value of the pack of cookies?



2

$$42 + 42 + 42 = 126$$

$$42 + 10 + 10 = 52$$

$$10 + 42 + 4 = 56$$

$$4 + 10 + 2 = 16$$

What is the value of the candy?



2

$$7 + 7 = 14$$

$$7 + 19 = 26$$

$$19 + 18 = 37$$

$$18 + 3 = 21$$

What is the value of the gum?



3

$$25 + 25 + 25 = 75$$

$$25 + 3 + 3 = 31$$

$$3 + 25 + 11 = 39$$

$$11 + 3 + 6 = 20$$

What is the value of the popcorn?



6

MYSTERY NUMBER

13

# TOTAL TRIVIA

Read each statement below and determine if it is true or false. If the statement is true, colour the coin that corresponds to that question. If it is false, cross out the coin. When you are finished add the TOTAL of ALL TRUE coins.



A. Niagara Falls is located entirely within Canada.

A. FALSE



B. The Canadian Rockies are part of the longest mountain range in the world.

B. TRUE (25)



C. Canada is home to the world's longest street, Yonge Street in Toronto.

C. TRUE (100)

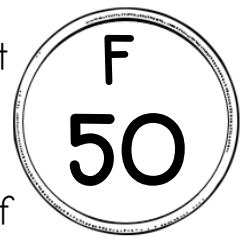

D. Hockey is the official national sport of Canada.

D. FALSE

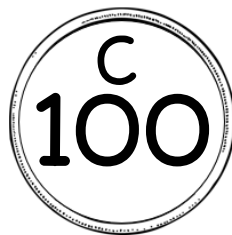

E. Canada has more lakes than any other country in the world.

E. TRUE (100)



F. The world's largest beaver dam is located in Wood Buffalo National Park, Canada.

F. TRUE (50)



G. Canada is the second-largest country in the world by land area, after Russia.

G. TRUE (25)



H. The North Pole is located within Canadian territory.

H. FALSE

## TOTAL

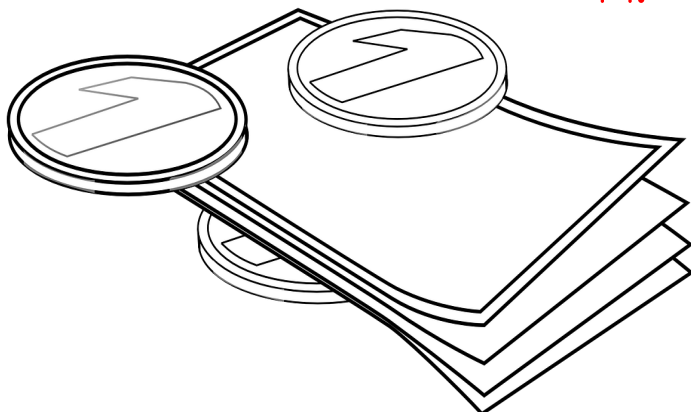

TOTAL 300

# TERMS OF USE

Copyright © TROUT LAKE CREATIONS. All rights reserved. This product is to be used by the original downloader only. No part of this document may be reproduced, distributed, sold or transmitted in any form or by any means, without the prior written permission of the copyright holder. This product may not be distributed or displayed digitally for public view. Failure to comply is a copyright infringement and a violation of the Digital Millennium Copyright Act (DMCA). Clipart and elements found in this product are copyrighted and cannot be extracted and used outside of this file without permission or license. PERSONAL USE ONLY. All pages in this download are copyrighted. You may not create anything to share or sell based on this download.

## YOU MAY:



Use the resource for personal use only.



Print and make copies of downloadable resources as necessary for your party.



Share my cover page on social media as long as you include the product link for my store.

## YOU MAY NOT:



Change or alter the product in any way aside from omitting pages you do not want to use.



Share this download with other people, friends, colleagues, family, for their own usage, etc. Additional licenses can be purchased at a lower rate.



Create anything to share or sell, in part or in whole, based on this download, including for your own commercial gain.



Upload this resource to websites, applications, shared drives or other sites or services that enables access by anyone other than you.

**CREDITS:** Graphics from Creative Fabrica, fonts from Bunny on a Cloud.